

Mounting Solutions Product Selection

100 Series

100 Series Mounting Solution Pivots provide tilt and portrait/landscape adjustment. Mount them to most vertical surfaces. Their low profile is perfect for space-constrained areas.



Range of Motion

Pivot/Tilt...

- Single Pivot w/ P/L: 180° up/down tilt; 360° portrait/landscape
- Double Pivot w/ P/L: 180° up/down tilt; 360° portrait/landscape; 180° left/right tilt
- Keyboard/Laptop Pivot: 180° up/down tilt

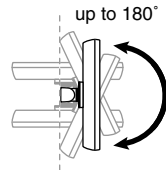

Side View
Up/down tilt

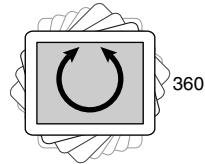

Front View
Portrait/landscape

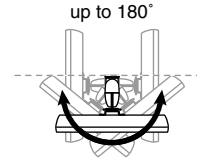

Top View
Left/right tilt

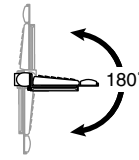

Side View
Up/down tilt

100 Series

Pivots attach to walls, machines and other vertical surfaces.



47-092-800

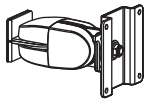

47-093-800

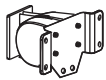

47-094-800

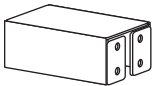

60-197-xxx

Part Number	Description	Weight Capacity	Shipping Weight
Monitor Mounts			
47-092-800, grey/black	Single Pivot w/ P/L, includes grey and black plastic covers	25 lbs (11.3 kg)	2 lbs (.9 kg)
47-093-800, grey/black	Double Pivot w/ P/L, includes grey and black plastic covers	23 lbs (10.4 kg)	3 lbs (1.4 kg)
Keyboard/Laptop Mounts			
47-094-800, grey/black*	Keyboard/Laptop Pivot, includes grey and black plastic covers	7.5 lbs (3.4 kg)	2 lbs (.9 kg)
Extenders		Dimensions (L x W x D)	
60-197-100, grey	Extender, 5-inch	5" x 2" x 1-3/4" (127 x 51 x 44 mm)	
60-197-101, black			

* Keyboard/Mouse Tray or Laptop Tray ordered separately. (See page 46.)

Note: Monitor interfaces that are not VESA FDMI compliant require a separately ordered, adapter bracket. Contact your Sales Representative for more information. (See page 49 for details.)

Mounting Options & Accessories for 100 Series

Surface Attachment Options	Page #	Accessory Options	Page #
Direct Mounting, Wall Plates	40	Extender	above
Wall Tracks	41	Keyboard/Mouse Trays, Laptop Trays & Accessories	46
Command Posts	42	Monitor Interface Accessories	47
Pole Mounts	44	CPU Holders	47
Slatwall Components	45	Storage Components	48
Mobile WorkStands	36	Peripheral Table	48

Attention: For 100 Series dimensional information, see page 62.

Mounting Solutions Product Selection

DS400 Series



Ergotron's Neo-Flex LCD Stand, (P/N 33-288-CBL) featuring Constant Force (CF™) proprietary lift-and-pivot motion technology, has replaced the DS400 Stand.

Please visit our website at www.ergotron.com to learn more about the Neo-Flex LCD Stand and Ergotron's breakthrough CF technology.

DeskStand 400 (DS400 Series) is a free standing module that requires no bolting or clamping to a surface. It allows the user to easily adjust a flat panel monitor for maximum comfort and productivity. The sturdy construction is built to last, while its sleek design complements any desktop arrangement.

Range of Motion

Arm and Pivot Adjustment...

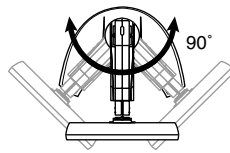

Top View
Side-to-side

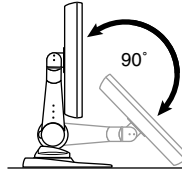

Side View
Vertical

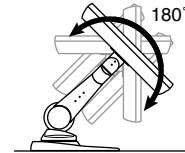

Side View
Up/down tilt

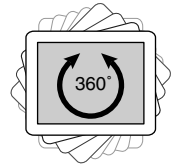

Front View
Portrait/landscape

DS400 Series

Includes mounting Arm, Pivot and Base in one complete package.

Part Number	Description	Weight Capacity	Shipping Weight
45-053-099, grey	DS400 Series	20 lbs	32 lbs
45-053-085, black		(9 kg)	(14.5 kg)

Note: Monitor interfaces that are not VESA FDMI compliant require a separately ordered, adapter bracket. Contact your Sales Representative for more information. (See page 49 for details.)

MD Series



NO LONGER AVAILABLE
57-014-200
MD101 Monitor Drawer

Monitor Drawers (MD Series) securely integrate a flat panel monitor and/or keyboard into a 19" rack-mount or enclosure. Store your flat panel folded down horizontally, ready to be pulled out for viewing. Drawers require only 3U of rack space. The MD Series provides a rock-solid platform, even for monitors with touch-screen capability. Cables are safely routed through the integrated cable management system.

MD Series

Drawers require only 3U of rack space.

Part Number	Description	Max. Monitor Weight	Shipping Weight
57-014-200, black	MD Series, MD101 Monitor-Only Drawer	25 lbs (11.3 kg)	14 lbs (6.4 kg)
57-013-200, black	MD Series, MD102 Monitor/Keyboard Drawer	25 lbs (11.3 kg)	25 lbs (11.3 kg)

Note: Monitor interfaces that are not VESA FDMI compliant require a separately ordered, adapter bracket. Contact your Sales Representative for more information. (See page 49 for details.)

Maximum Monitor Dimensions: MD101 accepts a monitor up to 16-1/2" H x 17-1/4" W x 3" D (419 x 438 x 76 mm); MD102 accepts a monitor up to 14-1/8" H x 17-1/4" W x 3" D (359 x 438 x 76 mm).

Attention: For MD Series dimensional information, see page 65.

Mounting Options & Accessories for DS400 Series (DS4) & MD Series (MD)

Surface Attachment Options	Accessory Options	Page #
DS4 – Free Standing	DS4 & MD – Wrist Rests & Mouse Accessories	46
MD – 19" Racks	DS4 – CPU Holders	47
	DS4 – Storage Components	48

Mounting Solutions Product Selection

DS100 Series



The DeskStand 100 (DS100 Series) positions up to five monitors on one base and up to eight monitors on a two-base configuration. Choose from three base options: Free Standing, Desk Clamp, or Grommet Mount. The DS100 Series utilizes Ergotron's patented Paraview Technology: view multiple monitors simultaneously, adjusting their position to a comfortable, ergonomically appropriate location.

Range of Motion

Clamping Pivots...

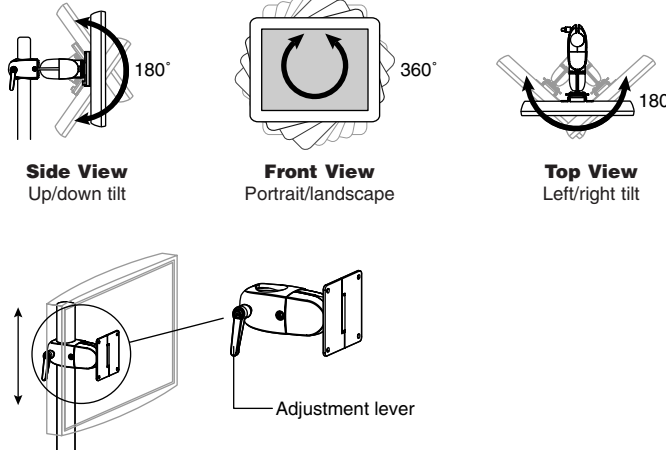

Motion range varies...

- Clamping Pivot: up/down tilt
- Clamping Pivot with P/L: up/down tilt; portrait/landscape
- Clamping Double Pivot: up/down tilt; left/right tilt
- Clamping Double Pivot with P/L: up/down tilt; left/right tilt; portrait/landscape

Sliding Pivots...

(Can be installed for left/right or up/down tilt)

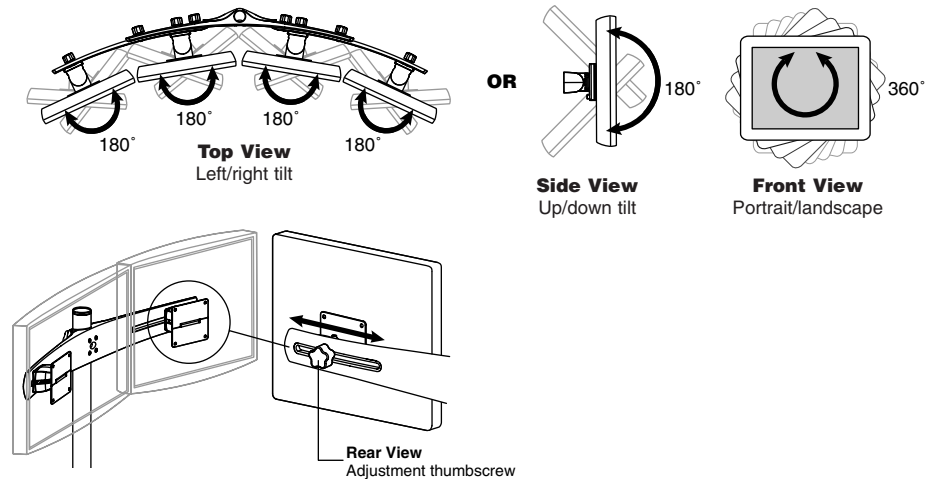

Motion range varies...

- Sliding Pivot: left/right or up/down tilt
- Sliding Pivot with P/L: left/right or up/down tilt; portrait/landscape

Attention: For DS100 Series dimensional information, see page 63.

**NO
LONGER
AVAILABLE**

33-090-200

Replaced with the Neo-Flex LCD Stand P/N: 33-288-CBL See www.ergotron.com for more information.

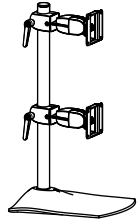

33-091-200



33-092-200

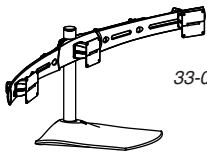

33-095-200

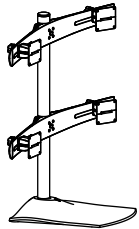

33-096-200

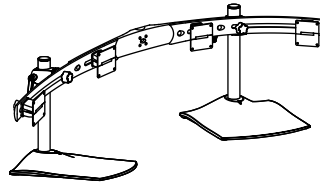

33-284-200

DS100 Series – Pre-configurations

Selections include Pivot(s), Free Standing Base, Pole and Crossbar(s) in one complete package. Standard color is black.

Part Number	Description	Weight Capacity per Pivot	Shipping Weight
33-090-200, black	Single Monitor Configuration: Free Standing Base, 14" Pole, Clamping Double Pivot w/ P/L	23 lbs (10.4 kg)	11 lbs (5 kg)
33-091-200, black	Dual Monitor Vertical Configuration: Free Standing Base, 28" Pole, (2) Clamping Double Pivots w/ P/L	23 lbs (10.4 kg)	16 lbs (7.3 kg)
33-092-200, black*	Dual Monitor Horizontal Configuration: Free Standing Base, 14" Pole, 28" Crossbar, (2) Sliding Pivots	28 lbs (12.7 kg)	16 lbs (7.3 kg)
33-095-200, black*	Triple Monitor Horizontal Configuration: Free Standing Base, 14" Pole, 46" Crossbar w/ Center Pivot, (2) Sliding Pivots	28 lbs (12.7 kg)	20 lbs (9.1 kg)
33-096-200, black*	Quad Monitor Square Configuration: Free Standing Base, 28" Pole, (2) 28" Crossbars, (4) Sliding Pivots	28 lbs (12.7 kg)	24 lbs (10.9 kg)
33-284-200, black*	Quad Monitor Horizontal Configuration: (2) Free Standing Bases, (2) 14" Poles, 55" Outboard Pole Clamps, (4) Sliding Pivots	28 lbs (12.7 kg)	31 lbs (14.1 kg)

* For allowable monitor widths, see page 63.

Note: Monitor interfaces that are not VESA FDMI compliant require a separately ordered, adapter bracket. Contact your Sales Representative for more information. (See page 49 for details.)

DS100 Series – Custom Configurations

Build your own DeskStand to your exact specifications with Ergotron's selection of interchangeable parts. Below are examples of possible configurations created with DS100 Series individual components (see next section).

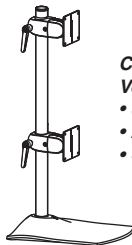

**Custom Example 1:
Vertical (V) Dual Monitor** includes:

- 33-262-200, Free Standing Base
- 20-137-200, 28" Pole
- 47-057-200, (2), Clamping Pivots

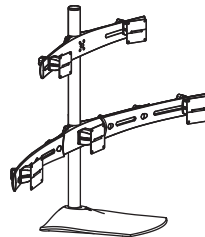

**Custom Example 3:
Pyramidal (P) Quint Monitor** includes:

- 33-262-200, Free Standing Base
- 20-137-200, 28" Pole
- 60-409-200, 28" Crossbar
- 60-410-200, 46" Crossbar w/ Center Pivot
- 47-046-085 (4), Sliding Pivots

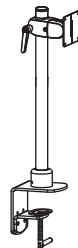

**Custom Example 2:
Single Monitor** includes:

- 60-349-200, Desk Clamp Base
- 20-136-200, 22" Pole
- 47-057-200, Clamping Pivot

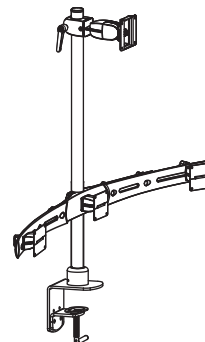

**Custom Example 4:
Pyramidal (P) Quad Monitor** includes:

- 60-349-200, Desk Clamp Base
- 20-161-200, 36" Pole
- 60-410-200, 46" Crossbar w/ Center Pivot
- 47-046-085 (2), Sliding Pivots
- 47-051-200, Clamping Double Pivot w/ P/L

Attention: For DS100 Series dimensional information, see page 63.

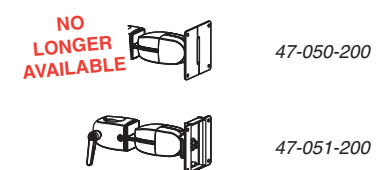
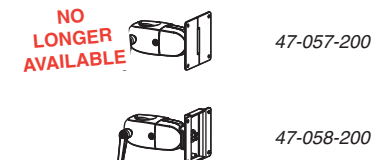
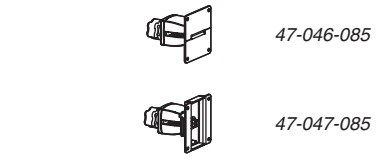
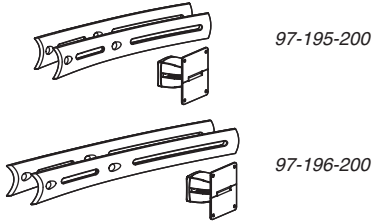
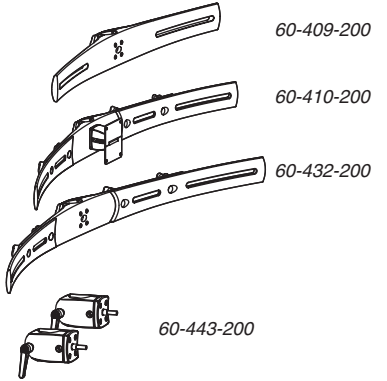
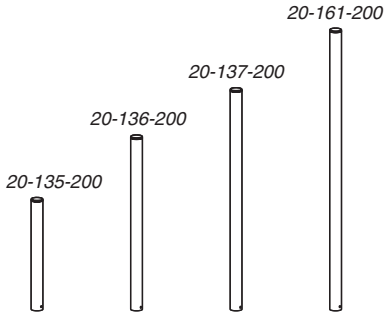

DS100 Series – Individual Components

Part Number	Description	Attach to...	Shipping Weight
Bases			
33-262-200, black	Free Standing Base	No attachment necessary	2 lbs (0.9 kg)
60-349-200, black	Desk Clamp Base	Worksurface edge ≤ 2-1/8" (54 mm) thick	5 lbs (2.3 kg)
60-350-200, black	Grommet Mount Base	Worksurface through hole 3/8" to 3" (10 to 76 mm) wide, up to ≤ 3-1/4" (83 mm) thick	5 lbs (2.3 kg)
Poles			
Recommended Configurations			
20-135-200, black	14" Pole, 1-1/2" diameter	Single, dual (H), triple (H), quad (H)	2 lbs (0.9 kg)
20-136-200, black	22" Pole 1-1/2" diameter	Single, dual (H), triple (H), quad (H)	5 lbs (2.3 kg)
20-137-200, black	28" Pole 1-1/2" diameter	Dual (V), triple (P), quad (S), quint	5 lbs (2.3 kg)
20-161-200, black	36" Pole 1-1/2" diameter	Dual (V), triple (P), quad (P, S), quint	5 lbs (2.3 kg)
Crossbars			
Recommended Configurations			
60-409-200, black*	28" Crossbar (mounts 2 Pivots)	Dual (H), triple (P), quad (S), quint	6 lbs (2.7 kg)
60-410-200, black*	46" Crossbar w/ Center Pivot	Triple (H), quad (P), quint Pivot (mounts 3 Pivots)	10 lbs (4.5 kg)
60-432-200, black*	55" Crossbar (mounts 4 Pivots)	Quad (H) – requires Outboard Pole Clamps & 2 Bases/Poles	11 lbs (5 kg)
60-443-200, black	Outboard Pole Clamps (1 set of 2 clamps)	Quad (H) – attaches 55" Crossbar to 2 Bases/Poles	3 lbs (1.4 kg)
Crossbar Extenders			
Application			
Converts...			
60-411-200, black*	Short Crossbar Extenders, Center Pivot	28" Crossbar to 46" Crossbar	4 lbs (1.8 kg)
60-436-200, black*	Long Crossbar Extenders, Center Pivot	28" Crossbar to 55" Crossbar	4 lbs (1.8 kg)
97-195-200, black*	Short Crossbar Extenders, Center Pivot	28" Crossbar to 46" Crossbar & adds Pivot to center	6 lbs (2.7 kg)
97-196-200, black*	Long Crossbar Extenders, Center Pivot	28" Crossbar to 55" Crossbar & adds Pivot to center	6 lbs (2.7 kg)
Pivots			
Attach to...			
Weight Capacity			
47-046-085, black	Sliding Pivot	Crossbar	28 lbs (12.7 kg) 2 lbs (0.9 kg)
47-047-085, black	Sliding Pivot w/ P/L	Crossbar	25 lbs (11.3 kg) 2 lbs (0.9 kg)
47-057-200, black	Clamping Pivot w/ P/L	Crossbar	28 lbs (12.7 kg) 3 lbs (1.4 kg)
47-058-200, black	Clamping Pivot w/ P/L	Pole	25 lbs (11.3 kg) 4 lbs (1.8 kg)
47-050-200, black	Clamping Double Pivot	Pole	25 lbs (11.3 kg) 5 lbs (2.3 kg)
47-051-200, black	Clamping Double Pivot w/ P/L	Pole	23 lbs (10.4 kg) 5 lbs (2.3 kg)

* For allowable monitor widths, see page 63.

Note: Monitor interfaces that are not VESA FDMI compliant require a separately ordered, adapter bracket. Contact your Sales Representative for more information. (See page 49 for details.)

Key for Recommended Configurations: (H) = horizontal; (V) = vertical; (P) = pyramidal; (S) = square.

Mounting Options & Accessories for DS100 Series

Surface Attachment Options	Page #	Accessory Options	Page #
Free Standing, Desk Clamp, Grommet Mount	above	Wrist Rests & Mouse Accessories	46
		CPU Holders	47
		Storage Components	48

Photo Reference for DS100 Series



Rear view of a horizontal dual-monitor DS100 configuration. Cables are routed through the crossbar.



A horizontal quad-monitor configuration – two bases support four monitors across a level plane while creating a viewing parabola with Ergotron's patented Paraview Technology.



A dual-monitor vertical configuration provides full tilt adjustability.



Close-up view of the Sliding Pivot on the Paraview bow. With the turn of the knob, a monitor is easily moved to accommodate multiple, different-sized screens on the same stand.



A triple-monitor configuration demonstrates the curve of a "viewing parabola," which maintains a single focal length for viewing.



Mount up to eight monitors on two bases for high-density work environments.