



# RocketDish™

airMAX® 2x2 PtP Bridge Dish Antenna

Models: RD-2G24, RD-3G26, RD-5G30, RD-5G30-LW, RD-5G34

Powerful Performance for Long-Range Links

---

Robust Design and Construction for Outdoor Use

---

Seamless Integration with Rocket Radios



# Overview

Pair a RocketDish™ antenna with a Rocket™ basestation to create the endpoint of a high-performance, Point-to-Point (PtP) bridge or network backhaul (Rocket sold separately).

The RocketDish is available in the following frequency models:

- 2.4 GHz
- 3 GHz
- 5 GHz

## Powerful Performance

The RocketDish antenna delivers 2x2, dual-polarity performance. On the right is one example of how the RocketDish with Rocket can be deployed in a backhaul link to deliver bandwidth from an ISP network out to a neighborhood tower. From there, an airMAX® Sector with Rocket delivers bandwidth to the ISP's customers.

## Carrier-Class Construction

Incorporating a dish reflector design for excellent beam directivity, the RocketDish antennas feature robust mechanical design using industrial-strength hardware for outdoor application use.

## Plug and Play Integration

RocketDish antennas and Rocket basestations have been designed to seamlessly work together. Every RocketDish has a built-in Rocket mount, so installation requires no special tools.

Snap the Rocket securely into place and mount the antenna; you then have the optimal combination of RocketDish and Rocket for your PtP application.

## Application Example

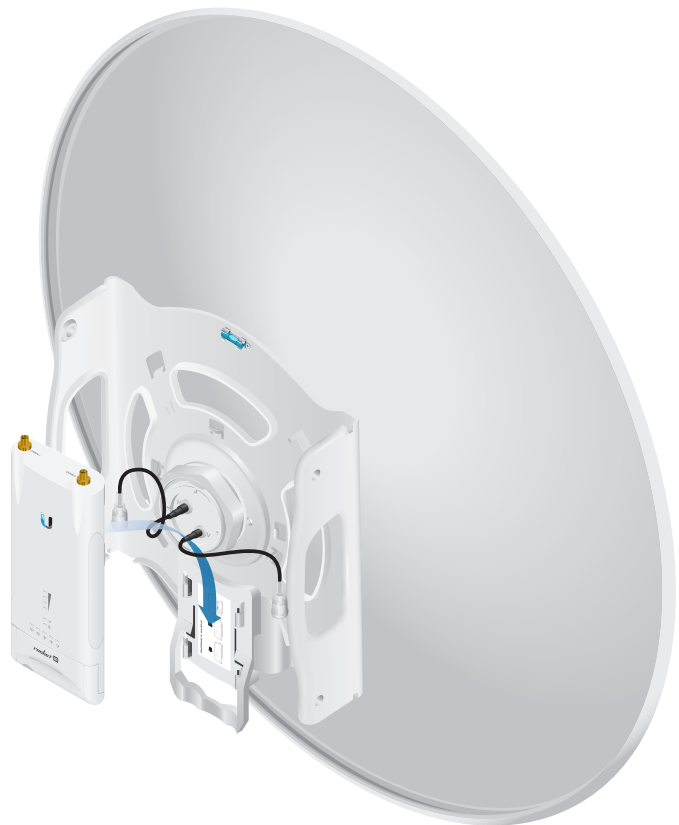
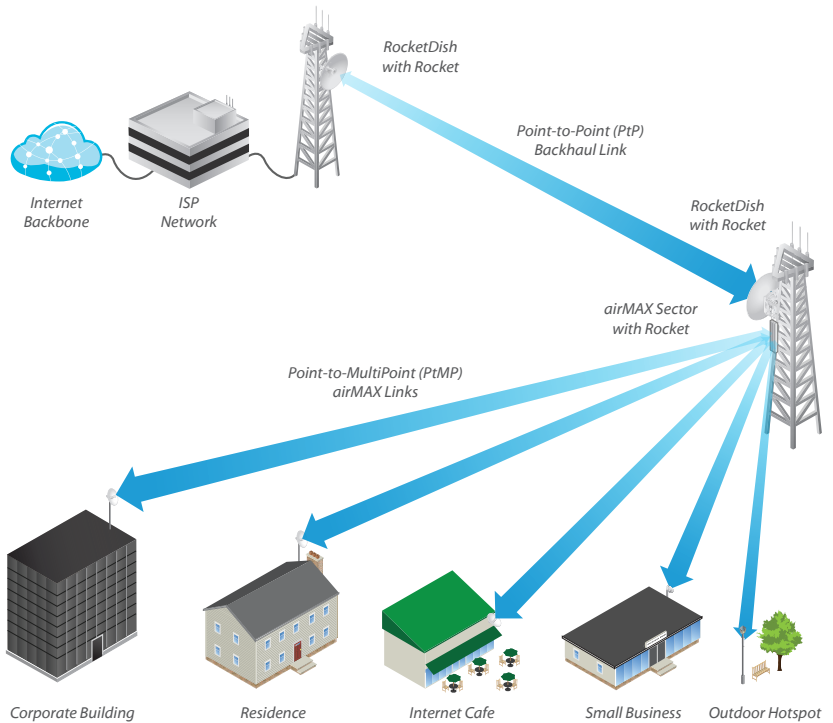

Mounting a Rocket on the RD-5G30-LW

# Hardware Overview

## Innovative Mechanical Design

- **Secure pole-mounting** The hardware is designed to securely mount and maintain the position of the dish during harsh outdoor conditions.
- **Convenient installation** The bubble level allows for easy alignment.
- **Precision elevation adjustment of the RD-5G30-LW** Use this new feature to quickly fine-tune and adjust the elevation.

## Weatherproof Design

- **Protective shroud** The shroud\* protects the cables and connectors from nature's elements.
- **Mounting hardware of the RD-5G30-LW** Made of galvanized steel that is powder-coated for superior corrosion resistance.
- **Fasteners of the RD-5G30-LW** GEOMET-coated for improved corrosion resistance when compared with zinc-plated fasteners.

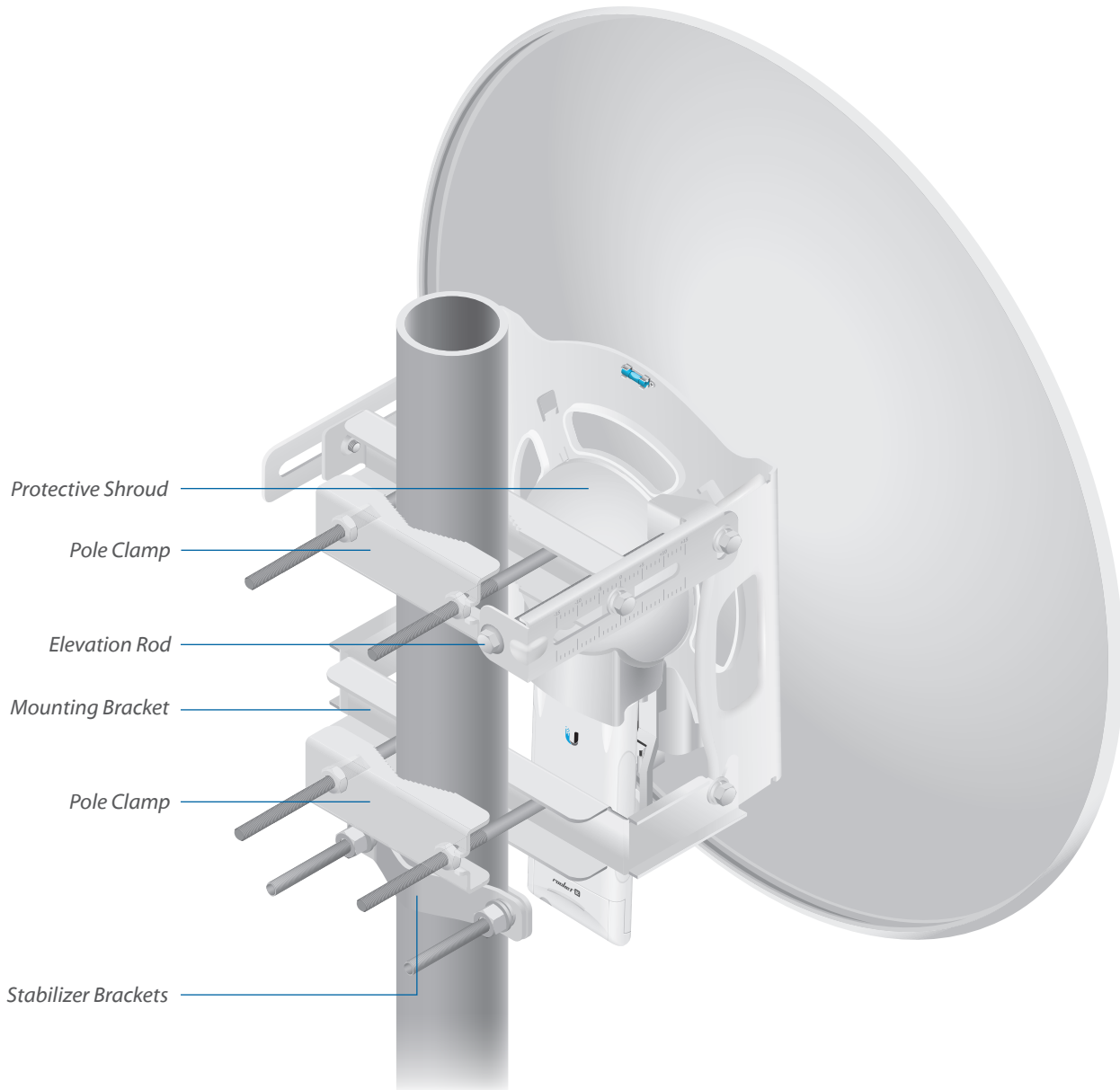

*Back View of the Fully Assembled RD-5G30-LW*

\* All models except for the RD-2G24 include a shroud.

## 2.4 GHz Model

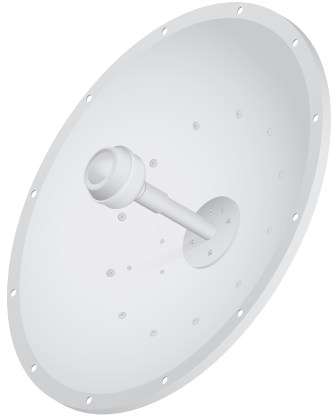

Model	Frequency	Gain	Radome*
RD-2G24	2 GHz	24 dBi	RAD-2RD

The 2.4 GHz frequency band is free to use, worldwide; however, it is extremely crowded due to interference from other wireless devices. Also, there are only three non-overlapping, 20 MHz channels available for use.

## 3 GHz Model



Model	Frequency	Gain	Radome*
RD-3G26	3 GHz	18 dBi	RAD-2RD

The 3 or 3.65 GHz frequency band is noise-free in most areas; however, its use requires a license. There may be additional restrictions on its use depending on local country regulations.

## 5 GHz Models



Model	Frequency	Gain	Radome*
RD-5G30	5 GHz	30 dBi	RAD-2RD

The 5 GHz frequency band is free to use, worldwide, offers plentiful spectrum, and works well for long-distance links. However, 5 GHz signals have more difficulty passing through obstacles than lower-frequency signals.



Model	Frequency	Gain	Radome*
RD-5G30-LW	5 GHz	30 dBi	ISO-BEAM-620

The RD-5G30-LW features the same gain as the RD-5G30 and adds the following advantages:

- Lightweight yet robust components lessen the load.
- The extended depth of the dish reflector rejects noise interference in co-location deployments.
- The design of the mounting bracket allows for ease of installation on a pole or tower.



Model	Frequency	Gain	Radome*
RD-5G34	5 GHz	34 dBi	RAD-3RD

The RD-5G34 offers 34 dBi of gain in a 1050-mm diameter size.

\* A radome is available as an optional accessory.

# RocketDish™ Radome

Models: RAD-2RD, RAD-3RD



Model	RD-2G24	RD-3G26	RD-5G30	RD-5G30-LW	RD-5G34
RAD-2RD	✓	✓	✓		
RAD-3RD					✓

A protective radome is available as an optional accessory for the RD-2G24, RD-3G26, RD-5G30, and RD-5G34. The RAD-2RD or RAD-3RD provides the following advantages:

- Reduces wind load
- Protects antenna surfaces from nature’s harshest elements
- Conceals antenna feed equipment from public view

# airFiber® X Conversion Kit

Model: AF-5G-OMT-S45



Model	RD-2G24	RD-3G26	RD-5G30	RD-5G30-LW	RD-5G34
AF-5G-OMT-S45			✓		✓

The 5 GHz RocketDish to airFiber® Antenna Conversion Kit converts the RocketDish RD-5G30 or RD-5G34 antenna for use with the airFiber AF-5X radio.

# RocketDish™ LW

## Accessories

### IsoBeam™

**Model: ISO-BEAM-620**



The IsoBeam™ is an isolator radome that is available as an optional accessory for the RD-5G30-LW. Its innovative RF-choke perimeter delivers breakthrough isolation performance in co-location deployments, and the integrated radome provides additional advantages:

- Reduces wind load
- Protects antenna surfaces from nature's harshest elements
- Conceals antenna feed equipment from public view

The IsoBeam is also compatible with other dish antennas:

- PowerBeam™ PBE-5AC-620
- PowerBeam PBE-M5-620

### Precision Alignment Kit

**Model: PAK-620**

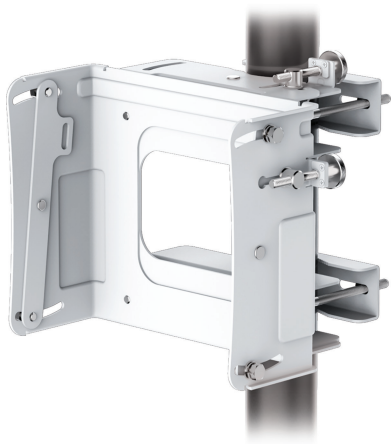

The Precision Alignment Kit is available as an optional accessory for the RD-5G30-LW. It features 15° of azimuth adjustment and 15° of elevation adjustment to enable extremely accurate aiming for optimal PtP link performance.

The Precision Alignment Kit is also compatible with other dish antennas:

- airFiber® AF-5G30-S45
- PowerBeam PBE-5AC-620
- PowerBeam PBE-M5-620

## Specifications

Antenna Characteristics					
Model	RD-2G24	RD-3G26	RD-5G30	RD-5G30-LW	RD-5G34
Dimensions*	650 x 650 x 295 mm (25.6 x 25.6 x 11.61")	650 x 650 x 300 mm (25.6 x 25.6 x 11.81")	650 x 650 x 304 mm (25.6 x 25.6 x 11.97")	650 x 650 x 386 mm (25.6 x 25.6 x 15.2")	1050 x 1050 x 421 mm (41.34 x 41.34 x 16.57")
Weight**	9.8 kg (21.61 lb)	9.8 kg (21.61 lb)	9.8 kg (21.61 lb)	7.4 kg (16.31 lb)	13.5 kg (29.76 lb)
Frequency Range	2.3 - 2.7 GHz	3.3 - 3.8 GHz	5.1 - 5.8 GHz	5.1 - 5.9 GHz	5.1 - 5.8 GHz
Gain	24 dBi	26 dBi	30 dBi	30 dBi	34 dBi
HPOL Beamwidth	3.8° (RX Dish) 6.6° (TX Dish)	7° (6 dB)	5° (3 dB)	5.8° (3 dB)	3° (3 dB)
VPOL Beamwidth	3.8° (RX Dish) 6.6° (TX Dish)	7° (6 dB)	5° (6 dB)	5.8° (3 dB)	3° (6 dB)
F/B Ratio	50 dB (RX Dish) 65 dB (TX Dish)	33 dB	34 dB	30 dB	42 dB
Max. VSWR	1.6:1	1.4:1	1.4:1	1.6:1	1.4:1
Wind Loading	787 N @ 200 km/h (177 lbf @ 125 mph)			790 N @ 200 km/h (178 lbf @ 125 mph)	1,779 N @ 200 km/h (400 lbf @ 125 mph)
Wind Survivability	200 km/h (125 mph)				
Polarization	Dual-Linear				
Cross-pol Isolation	35 dB Min.				
ETSI Specification	EN 302 326 DN2				
Mounting	Universal Pole Mount, Rocket Bracket, and Weatherproof RF Connectors Included				

\* Dimensions exclude pole mount and Rocket (Rocket sold separately)  
 \*\* Weight includes pole mount and excludes Rocket (Rocket sold separately)



# RD-2G-24 Antenna Information

Return Loss

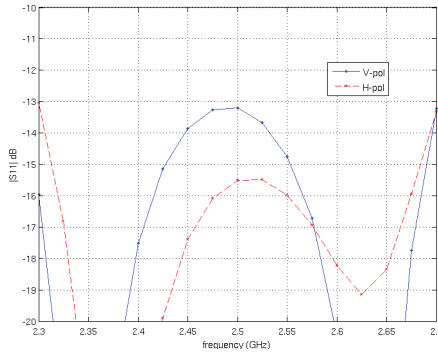

Vertical Azimuth

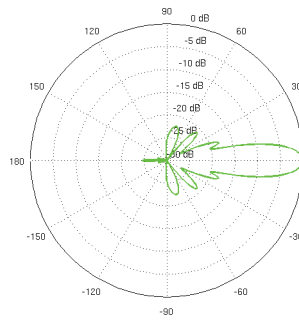

Vertical Elevation

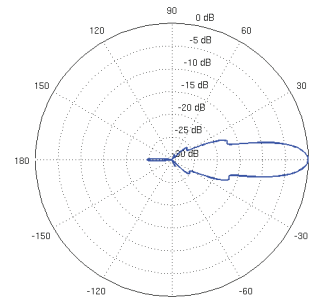

Horizontal Azimuth

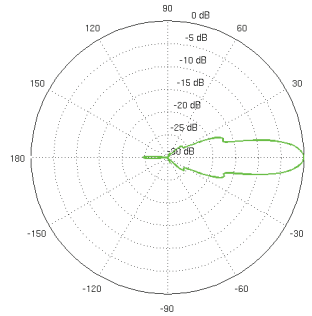

Horizontal Elevation

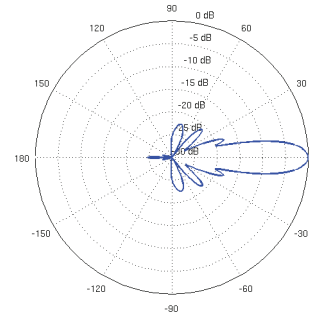

# RD-3G26 Antenna Information

Return Loss

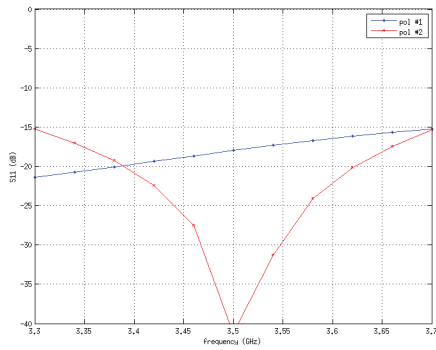

E-Plane, 3550 MHz

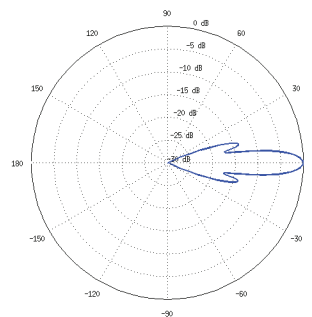

E-Plane Specs

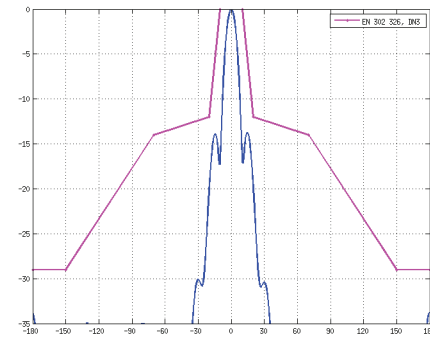

H-Plane, 3550 MHz

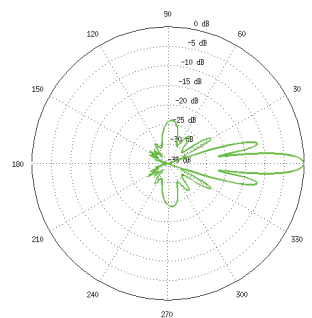

H-Plane Specs

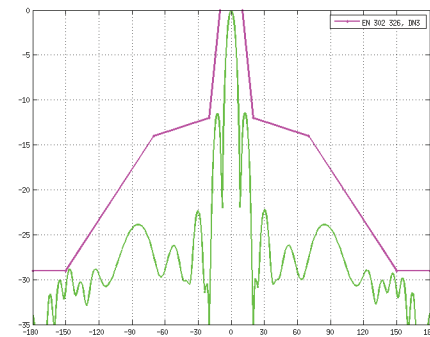

## RD-5G30 Antenna Information

E-Plane, 5500 MHz

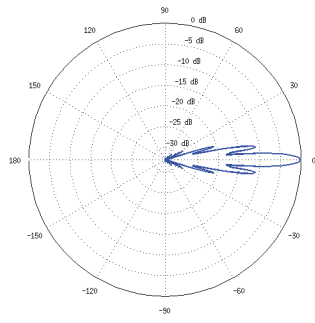

E-Plane Specs

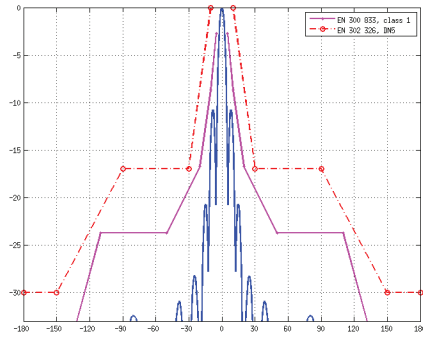

H-Plane, 5500 MHz

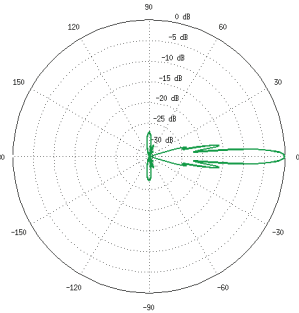

H-Plane Specs

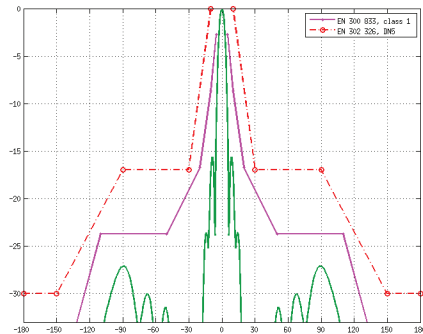

## RD-5G30-LW Antenna Information

Return Loss

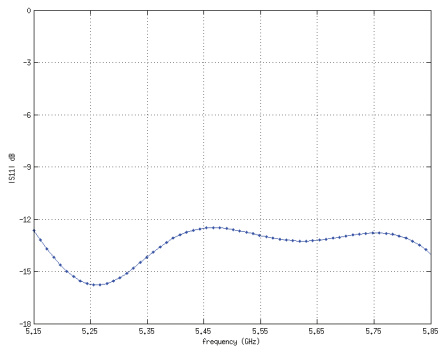

E-Plane, 5500 MHz

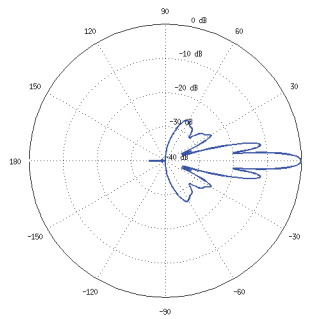

E-Plane Specs

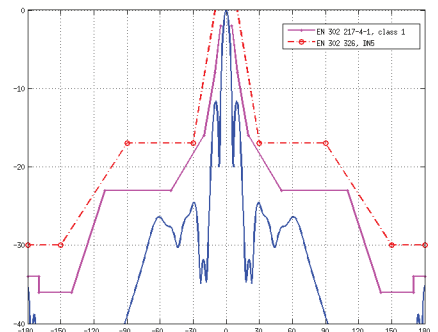

H-Plane, 5500 MHz

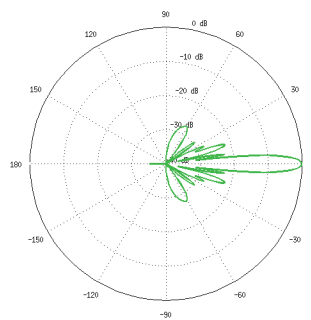

H-Plane Specs

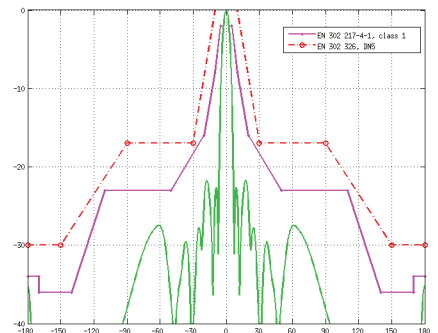

# RD-5G34 Antenna Information

E-Plane, 5500 MHz

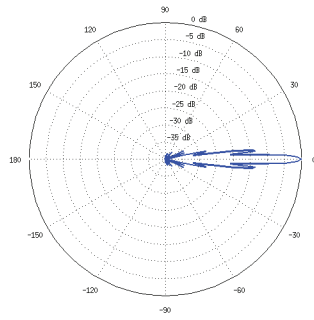

E-Plane Specs

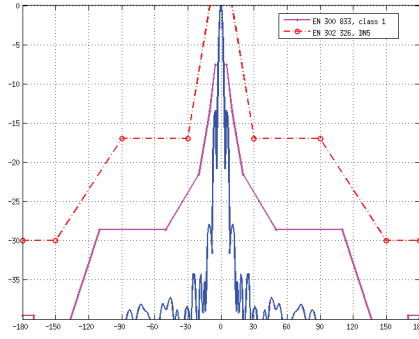

H-Plane, 5500 MHz

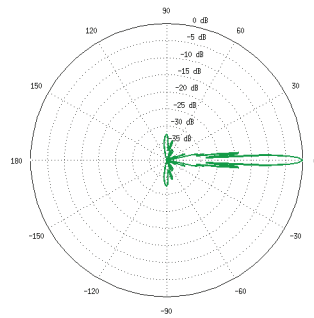

H-Plane Specs

